











La uni 2800 TAB es una cadena típica para el transporte de embalajes.

La cadena uni 2800 TAB está diseñada para marchar en ambos sentidos.

uni 2800 TAB

Cadenas uni Flex • Plástico

-  Giro lateral
-  82.5 mm (3.25 pulgadas)
-  Materiales Ver pág. 14
-  **SS304** Ver pág. 13
-  75 mm (2.9 pulgadas)
-  Ver pág. 115
-  Ver pág. 120
-  6.1 m = 20 ft
Nº eslabones/caja: 74
-  POM: 6000 N (1349 lbf)

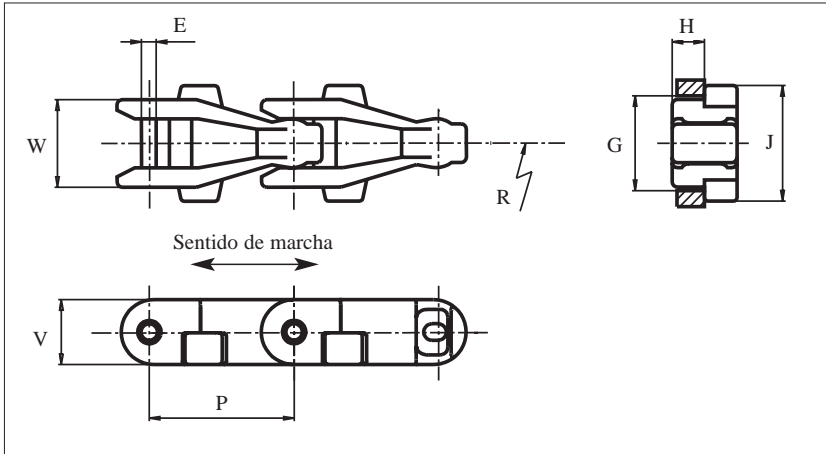

	mm	pul.		mm	pul.
E	9.5	0.37	J	67.4	2.65
G	54.0	2.13	P	82.5	3.25
H	18.1	0.71	V	37.3	1.47

Todas las dimensiones son para cadenas en acetal (POM).

Los artículos con referencia uni en **negrita** son estándar.
Los artículos con referencia uni en *cursiva* se suministran bajo pedido.

	referencia uni			ancho W		peso		radio mín. R	
	POM-D	POM-D	POM-LF	mm	pul.	kg/m	lb/ft	mm	pul.
uni 2800 TAB	38D2800TW	<i>38D2800TG</i>	<i>38LF2800T</i>	53.5	2.11	1.7	1.14	500	19.69